

FLUX DRIVE

ADJUSTABLE SPEED DRIVES

FLEXIBLE SOFT-START COUPLINGS

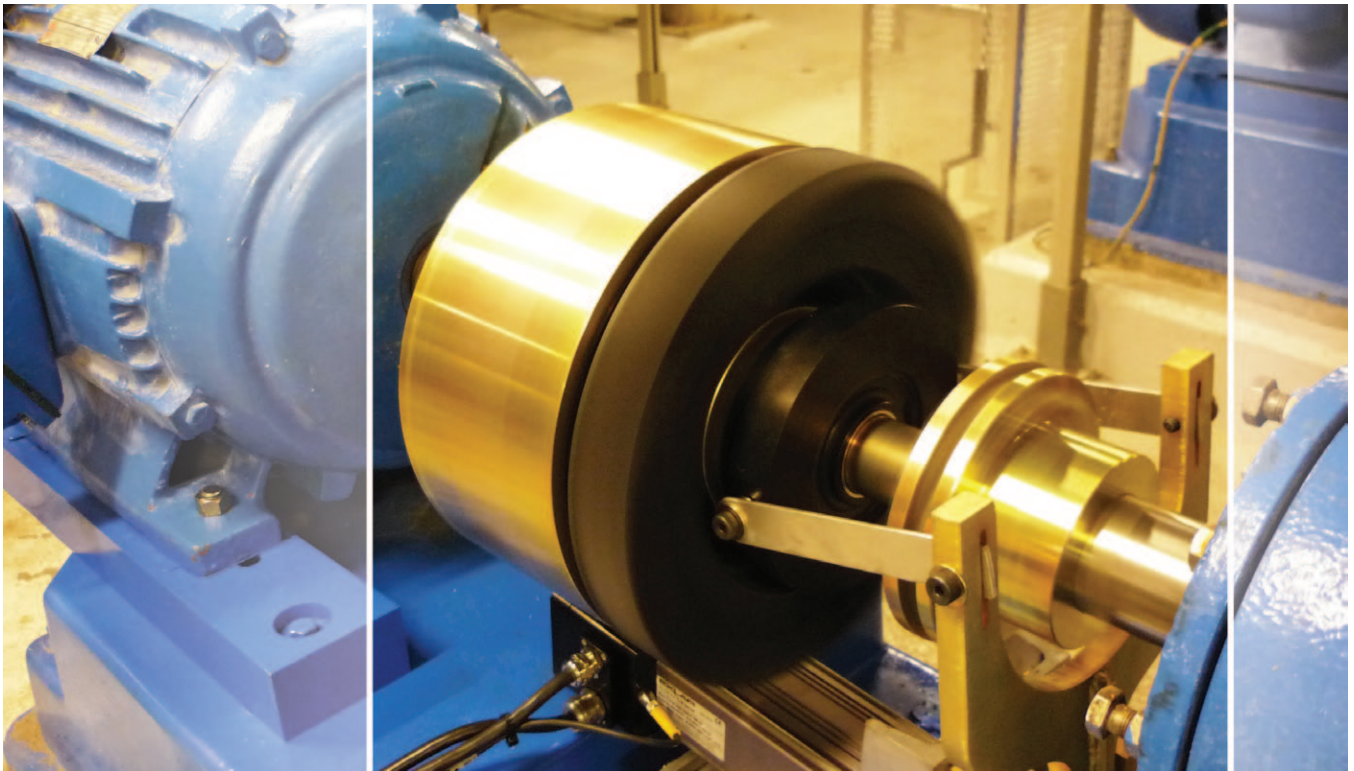

Reduces Peak Power Demand and Lowers Energy Consumption

FLUXDRIVE[®]
ENERGY EFFICIENCY MADE EASY

FLUX DRIVE TECHNOLOGY

Flux Drive technology utilizes portions of induction motor theory combined with recent improvements in permanent magnets to create a breakthrough design for flexible soft-start couplings and adjustable speed drives. Coupling torque is transferred across an air gap by means of magnetic induction. This unique magnetic circuit eliminates high-peak power demands during start-up and provides significant energy savings during reduced speed operations.



FLUX DRIVE DISENGAGED

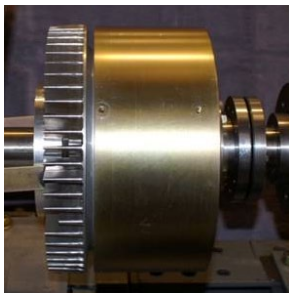

FLUX DRIVE FULLY ENGAGED

Engineered Efficiency

Flux Drive products allow the motor to run at a constant speed, and at its best efficiency point, while having the ability to provide speed control to the load. This patented induction type rotor design has several distinct advantages over other coupling and drive technologies:

- ▶ 98.5% efficient power transfer
- ▶ Reduces vibration
- ▶ Reduces system noise
- ▶ Reduces life cycle costs
- ▶ Operates in harsh environments
- ▶ Lower power requirements
- ▶ No harmonic interference
- ▶ Motor can be sized for the load
- ▶ 100% mechanical speed control device
- ▶ Eliminates coupling failures

Less Vibration and Noise

Due to the torsionally disconnected design, vibration created by a traditional flexible coupling is eliminated; thereby increasing the life of all the machine's components. Since torque passes through air via magnetic flux, with no physical connection, no parts wear out due to normal operations.

Safe and Reliable

Flux Drive products provide safe and reliable operation in harsh environments. A protective coating and simple efficient design guards against extreme temperature, moisture, seawater, salt air, and chemical corrosion. All couplings and drives meet international classification design standards.

Retrofit to Existing Motors

Flux Drive products easily retrofit to existing motors without upgrading to inverter duty. This innovative design accepts large degrees of misalignment. Alignment is performed by using a simple air gap spacer method. No expensive laser alignment system is needed.

Simple Efficient Design

With no electrical windings and no electricity creating the magnetism, no harmonics or power fluctuations interfere with operations.

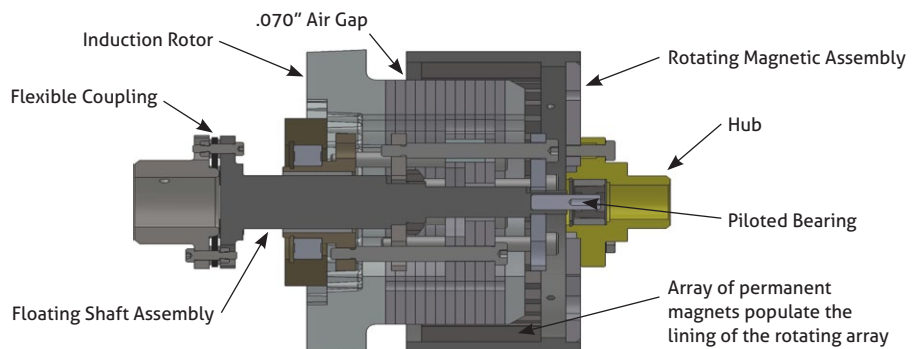

FLEXIBLE SOFT-START COUPLINGS

Reduces peak power demand and lowers energy consumption.

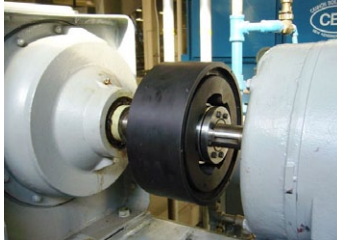

Flux Drive Flexible Soft-Start Couplings provide an almost one-to-one transfer of power from the motor to the load. Couplings are sized to transfer 100% of the motor's torque at 1.5% slip (98.5% efficient).

The couplings are simple mechanical devices that are easy to install and require no electrical training (unlike other soft-start solutions using sensitive electronics). Ongoing operation and maintenance is affordable with no touching parts or sensitive electrical components to replace.

- ▶ Provides soft-starting of driven machinery
- ▶ Eliminates harmonics that interfere with system performance
- ▶ Eliminates potential damage from load shaft seizures
- ▶ Provides immunity from power spikes, sags, or dirty power effects
- ▶ Has higher operating efficiencies than other magnetic drives

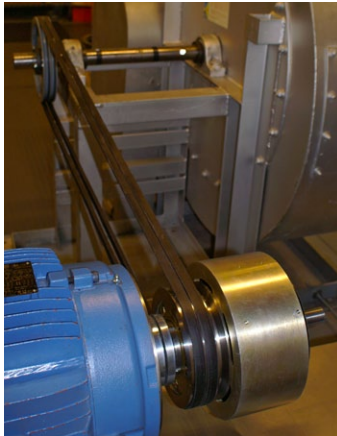

Eliminates Locked Rotor Conditions

By relying on the coupling's air gap, a motor can fully breakaway from the load and accelerate to full motor speed without high locked rotor currents. The Flux Drive Flexible Soft-Start Coupling reduces start-up current by limiting it to the safe value of 140% of full load rating.

ADJUSTABLE SPEED DRIVES

Flux Drive is ultimately about saving energy by varying the drive speed.

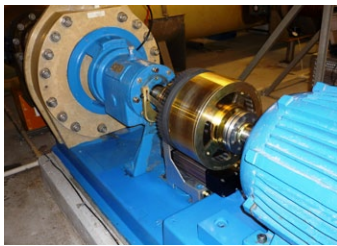

The Flux Drive Adjustable Speed Drive (ASD) is a Soft-Start Coupling with the ability to configure the linear engagement between the rotating magnet can and rotor. Adjustable speed is achieved by controlling the overlap of the can and rotor. As the can and rotor are disengaged, the slip increases allowing the output speed to decrease proportionally.

Energy Savings

In centrifugal applications, system power requirements vary with the cube of the pump speed. Small decreases in speed or flow can significantly reduce energy use. For example, reducing the speed by 20% can reduce input power requirements by as much as 50%.



Easy to Install

The Flux Drive system creates no harmonics and therefore requires no complex filtering systems. Unlike variable frequency drives, no air conditioning or other devices are needed.

- ▶ Simple installation: in-line or with belt-driven arrangement
- ▶ Speed set by auto actuation (4-20 mA) or manual adjustment
- ▶ 100% mechanical speed control device



More information at www.fluxdrive.com

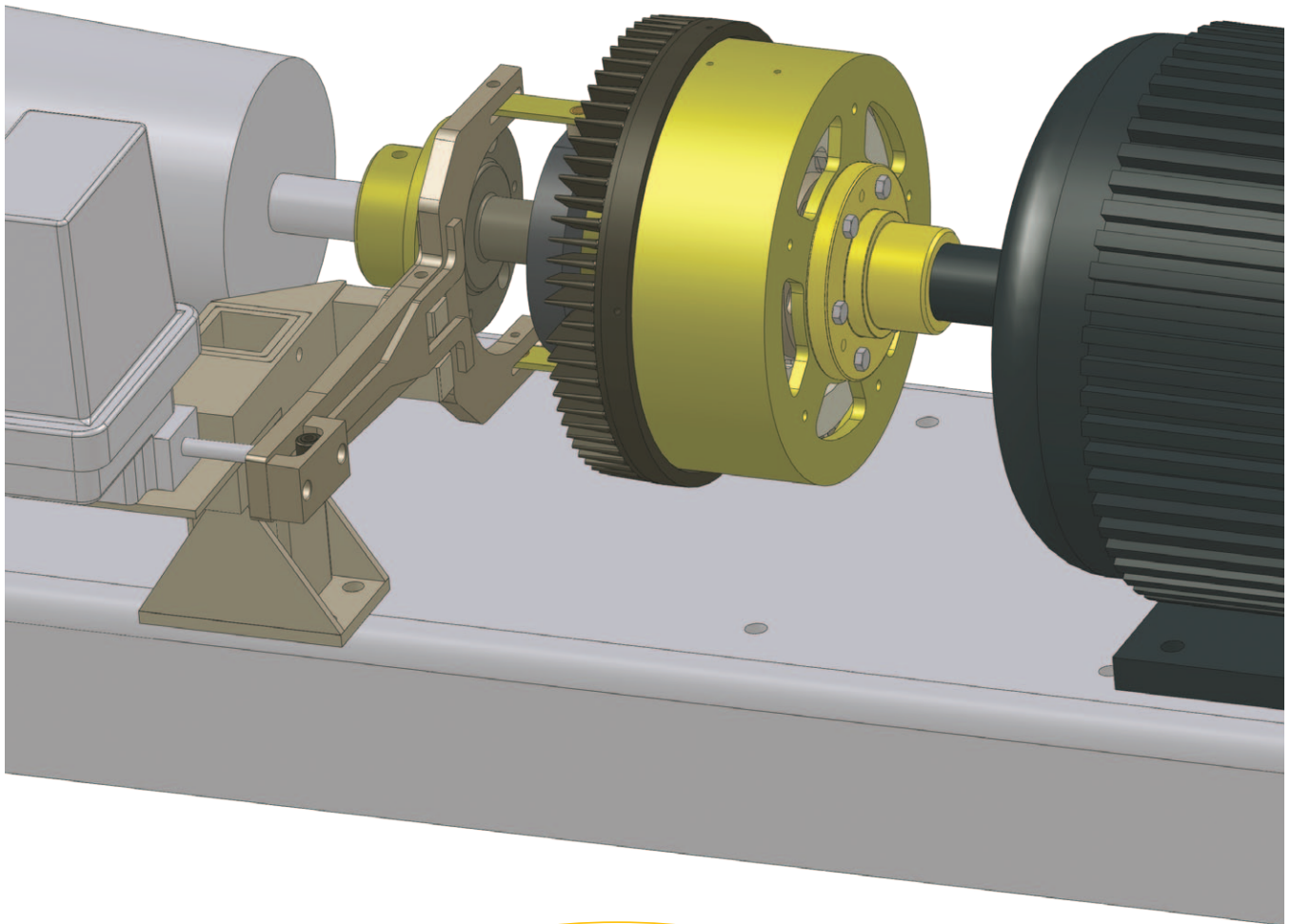

FLUXDRIVE[®]
ENERGY EFFICIENCY MADE EASY

Flux Drive Inc. 14209 - 29th Street East Suite 105 Sumner, Washington 98390
Phone: 253.826.9002 Fax: 253.826.9004 Web: www.fluxdrive.com



The Flux Drive name and logo are registered trademarks of Flux Drive Inc.

